



9th ASEAN IP Register Coordinators Meeting

Topic 2 Platform Development Update

*WIPO IP Office Business Solutions
Online, September 23, 2025*

Platform Improvements in June 2025

- Infrastructure Improvement with scalable cloud resources
- Optimized data loading process
 - 2000 applications per minute / full ASEAN collection of all 3 IP types in 3 days (7.5 M application data + images, documents)

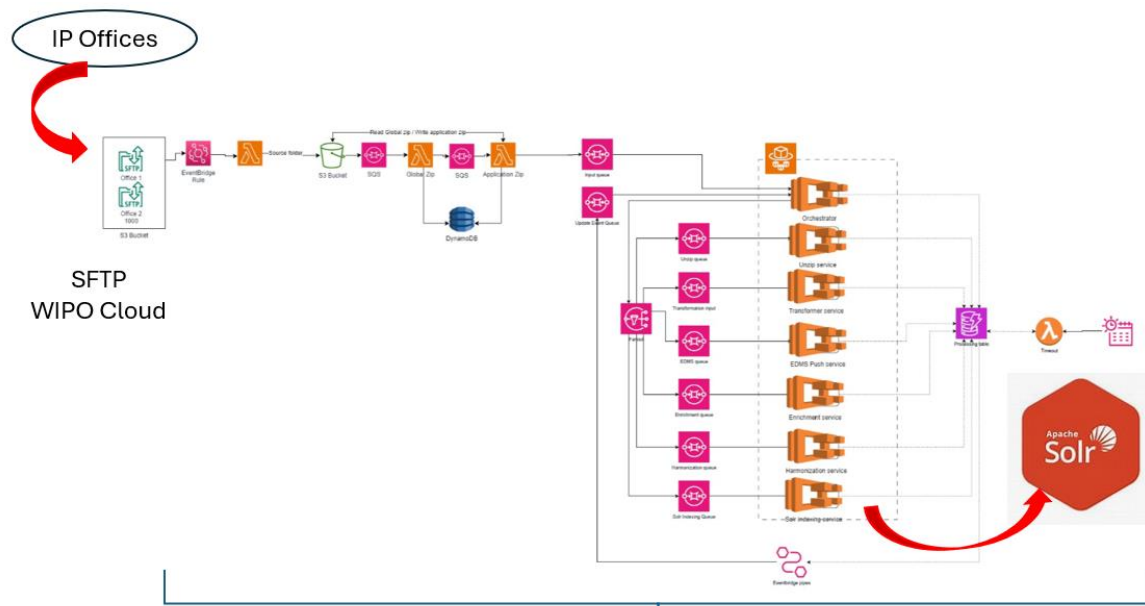

WIPO Cloud data loading
(data transformation and creation of search indexes)

Platform Improvements in August 2025

- Optimized the search data structure to allow search in the latest application data snapshots, but can be extended in future to historical data snapshots
 - Applications data as published (snapshot history)
 - Applications as granted (latest snapshots)
- Improved system performance (~3 seconds response time)
- View application snapshots, for example
 - Application data as published, as granted and status changes
 - 3 WIPO standard key events
(publication before grant, grant and status changes)
- Encrypted URL paths to prevent data scraping

Platform Improvements in August 2025

■ ASEAN Geographical Indications (GI) database

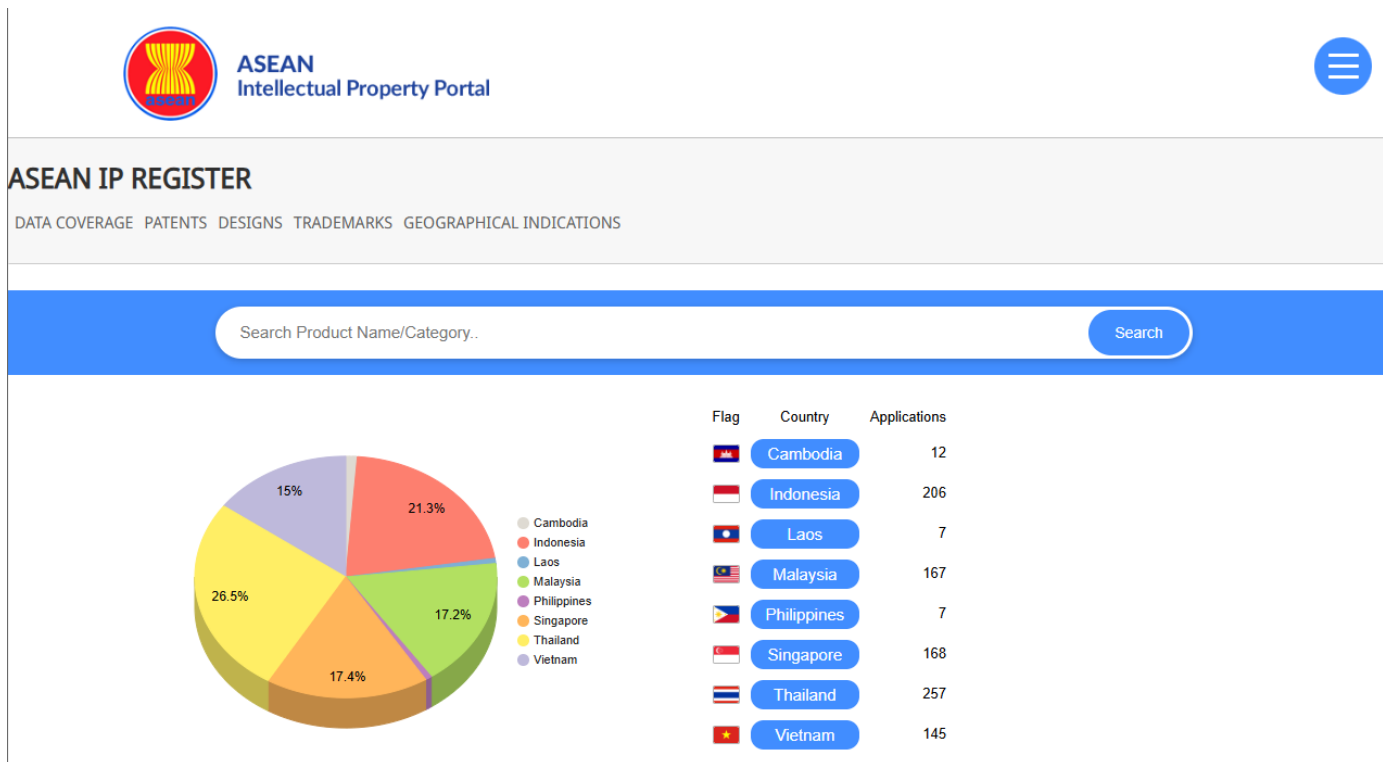

Platform Improvements in August 2025

■ Search by GI names or product categories

The image displays three screenshots of the ASEAN Intellectual Property Portal's IP Register, illustrating search capabilities for Geographical Indications (GI) related to coffee. Red arrows indicate the flow of information from the search results to the detailed entry view.

Top Left Screenshot: Search Results Overview

The search results for 'coffee' are displayed in a list format. A pie chart shows the distribution of coffee GIs by country:

Country	Count
Philippines	7
Indonesia	168
Thailand	257
Vietnam	145

Top Right Screenshot: Search Results Grid

The search results are shown in a grid view. The first entry is:

- ARABICA COFFEE DIENG MOUNTAINS BANJARNEGARA**
Right Holder Name(s): The Dieng Mountains Arabica Coffee Geographical Indication Protection Society, Banjarnegara
Country of Registration: Indonesia
Geographical Origin(s): Indonesia
Type of Product: coffee
Registration Number & Date: ID G 000000119 / 2022-07-01

Bottom Screenshot: Detailed Entry View

The detailed view for **BALIEM WAMENA ARABICA COFFEE** is shown. Key information includes:

- Right Holder Name(s): Geographical Indication Protection Society of Baliem Wamena Arabica Coffee
- Country of Registration: Indonesia
- Geographical Origin(s): Indonesia
- Type of Product: Coffee
- Registration Number & Date: ID G 000000083 / 2019-08-23

The detailed view also includes a 'Main Features' section with a description in Indonesian and English, and a 'Geographic Area' section.

Platform Improvements in August 2025

- National collections and portals for integration with AMS Offices' websites

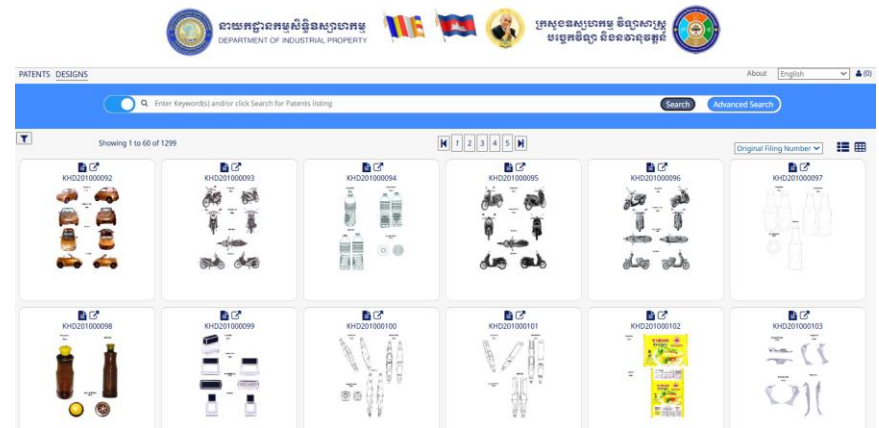
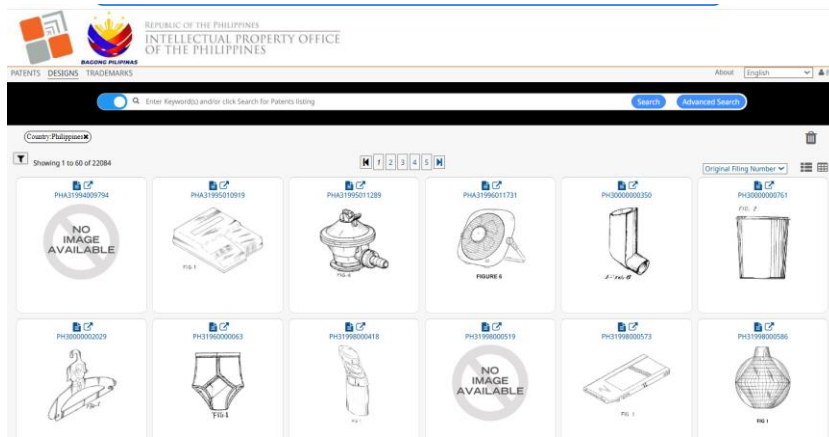

Platform Improvements in August 2025

- Sharing of Authority Files through ASEAN IP Register (WIPO Publish Cloud)

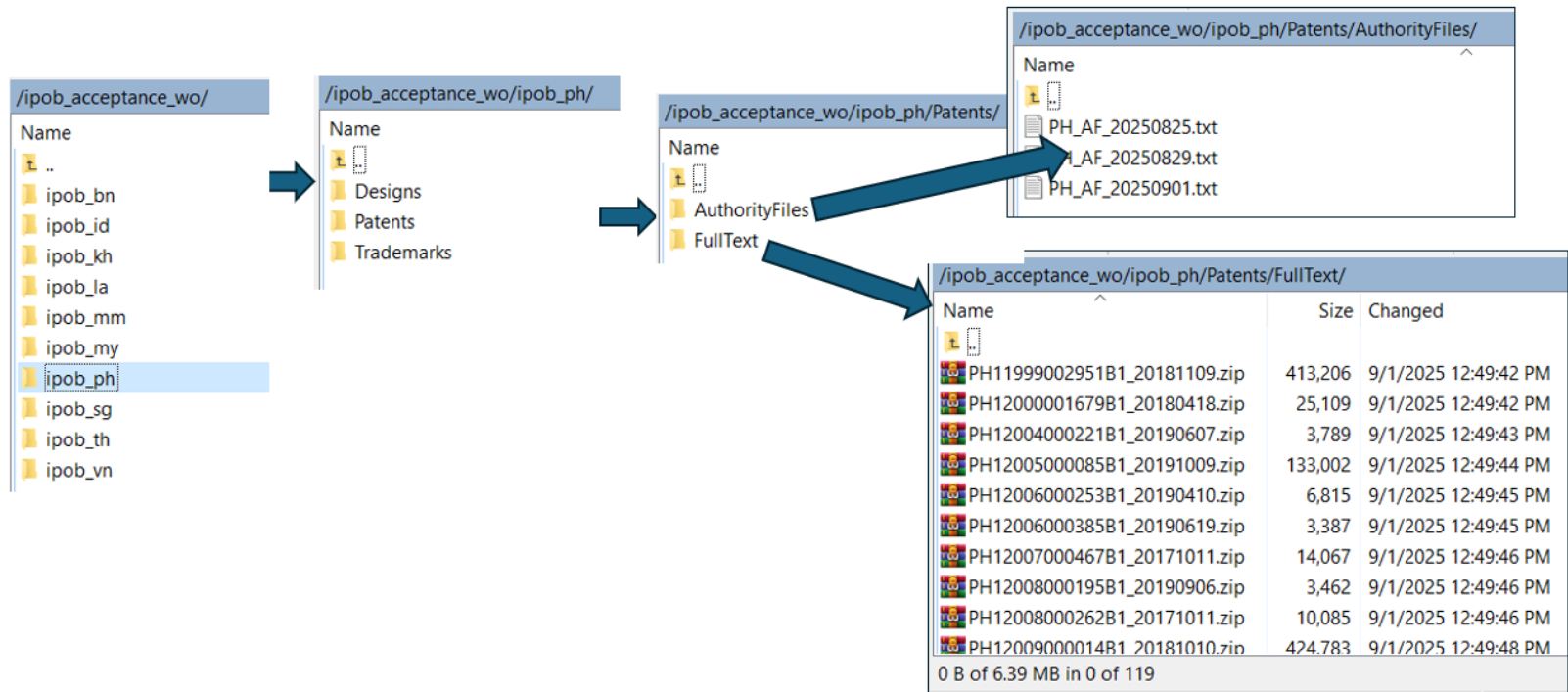

Platform Improvements in August 2025

■ Authority files in CSV format

```
OFFICE-CODE,PUBLICATION NUMBER,KIND CODE,PUBLICATION DATE,EXCEPTION_CODE,ABSTRACT,DESCRIPTION,CLAIMS
PH,11999002951,B1,2018-11-09,,ABST-en,DESC-en,CLMS-en
PH,12000001679,B1,2018-04-18,,ABST-en,DESC-en,CLMS-en
PH,12004000221,B1,2019-06-07,,ABST-en,DESC-en,CLMS-en
PH,12005000085,B1,2019-10-09,,ABST-en,DESC-en,CLMS-en
PH,12006000253,B1,2019-04-10,,ABST-en,DESC-en,CLMS-en
PH,12006000385,B1,2019-06-19,,ABST-en,DESC-en,CLMS-en
```

■ Auto-generated definition of authority files in PDF format

DEFINITION FILE FOR «ipOfficeCode» AUTHORITY FILE

This definition file relates to the following authority file: «fileName»

Date of production

«dateOfProduction»

Data coverage

Public PH documents from «startDate» to «lastDate».

The PH authority file lists all PH patent and PH utility model publications. Coverage according to document type and kind-of-document code (see Part 7.3 of the WIPO Handbook for details on kind codes):

Type	Kind Code	Total
«TableStart:mapTotalKindCode» «type»	«kindCode»	«count»«TableEnd:mapTotalKindCode»

Used options

- Application information is provided where available
- Priority data not included
- Availability of abstract, description and claims of the publication in text-searchable format
- Currently, publication exception codes are not in use, and the corresponding values in the authority file remain empty. However, in the future, exception cases may be added as applicable

WIPO Standard ST.37

<https://www.wipo.int/export/sites/www/standards/en/pdf/03-37-01.pdf>

Platform Improvements in August 2025

- Availability through the WIPO Authority File Portal
- PCT minimum documentation available to authorized ISA
- Authority file services

Authority File Full-Text Data Service - A...

- POST GetApiClientCredentials
- GET Get Latest Authority File
- GET Get Definition file
- GET Get Full Text
- GET Negative Case 1 - Get Full Text
- GET Negative Case 2 - Get Full Text

WIPO English IP Portal login

Understand & Learn Find & Explore Protect & Manage Partner & Collaborate About WIPO



Home > WIPO Standards

Authority File of Published Patent Documents Provided by Offices

The main purpose of the authority file of published patent documents is to allow all interested parties to assess the completeness of the available patent documentation from the intellectual property office (IPO) that generated the authority file.





On this page, you can find the most recent authority files compliant with [WIPO Standard ST.37](#)  which have been provided by the IPOs to the International Bureau of WIPO or links to the webpages where such authority files are hosted. The recommendations on data elements, structure and format of authority files are provided in WIPO ST.37.

The icons included within the table indicate the file type of the authority file, and will initiate a download when clicked.

PH			1990-01-01 onwards	Updated monthly
----	--	--	--------------------	-----------------

The authority file guidelines aim to ensure that authority files provided to the international bureau are both compliant with WIPO Standard ST.37 and consistent across Offices.

This page was last updated on August 8, 2025.

IP Office	Authority file	Definition file	Coverage	Remark
AT			1990-01-01 to 2025-02-28	Updated monthly; published here biannually.
AU			1905-12-04 onwards	Updated monthly
PH			1905-12-04 onwards	Updated monthly

Platform Improvements in August 2025

- ASEAN Patent collection available through WIPO CASE as providing offices services (bibliographic data, document list, document content)

The screenshot shows a web application interface. On the left is a sidebar with a tree view of API endpoints. The endpoint `GET case_doccontent` under the `Publish_API` folder is highlighted with a red box. The main window displays a REST client interface with a `GET` request to `https://api.wipublish.wipublish-prd.ipobs.prd.web1.wipo.int/wopublish-wipocase/biblio/application/original/SG10202104718V`. The response is a JSON array of two objects, each representing a document entry. The first object has a `contact` field with `personFullName` "LEE, Do Gyeong" and `inventorCountryCode` "KR". The second object has a `contact` field with `personFullName` "LEE, Ju Won" and `inventorCountryCode` "KR". Both objects have a `sequenceNumber` of 3. The `abstractBag` field contains a `paragraphBag` with a `text` field containing the abstract: "ABSTRACT A storage device including a nonvolatile memory device that includes a nonvolatile memory cell array including".

Platform Improvements in August 2025

- Data services api
(data sharing with third parties as received)
 - Retrieve application list by date range (filing, publication)
 - Retrieve application document list and document contents

The screenshot displays a REST client interface with the following components:

- Left Sidebar:** A tree view of API endpoints. The selected endpoint is `GET data-services` under the `data-service` folder.
- Request Bar:** Shows the method `GET` and the URL `https://data-exchange.wipopublish-prd.ipobs.prd.web1.wipo.int/data-services?ip-type-category=patents&ip-office-code=ph&date...`. A `Send` button is visible.
- Params Tab:** A table of query parameters with checkboxes for each key.
- Body Tab:** Shows the response body in JSON format.

Key	Value
<input checked="" type="checkbox"/> ip-type-category	patents
<input checked="" type="checkbox"/> ip-office-code	ph
<input checked="" type="checkbox"/> date-category	filing
<input checked="" type="checkbox"/> date-start	2008-12-01
<input checked="" type="checkbox"/> date-end	2008-12-31
<input type="checkbox"/> Key	Value

```
{
  "application-identifiers": [
    "PH1200800000469",
    "PH1200800000471"
  ]
}
```

Parallel Run (October – December 2025)

- A new beta release for parallel run features a modern, mobile-friendly user interface

<https://asean.wipopublish-webapp-prd.ipobs.prd.web1.wipo.int/en/datacoverage>

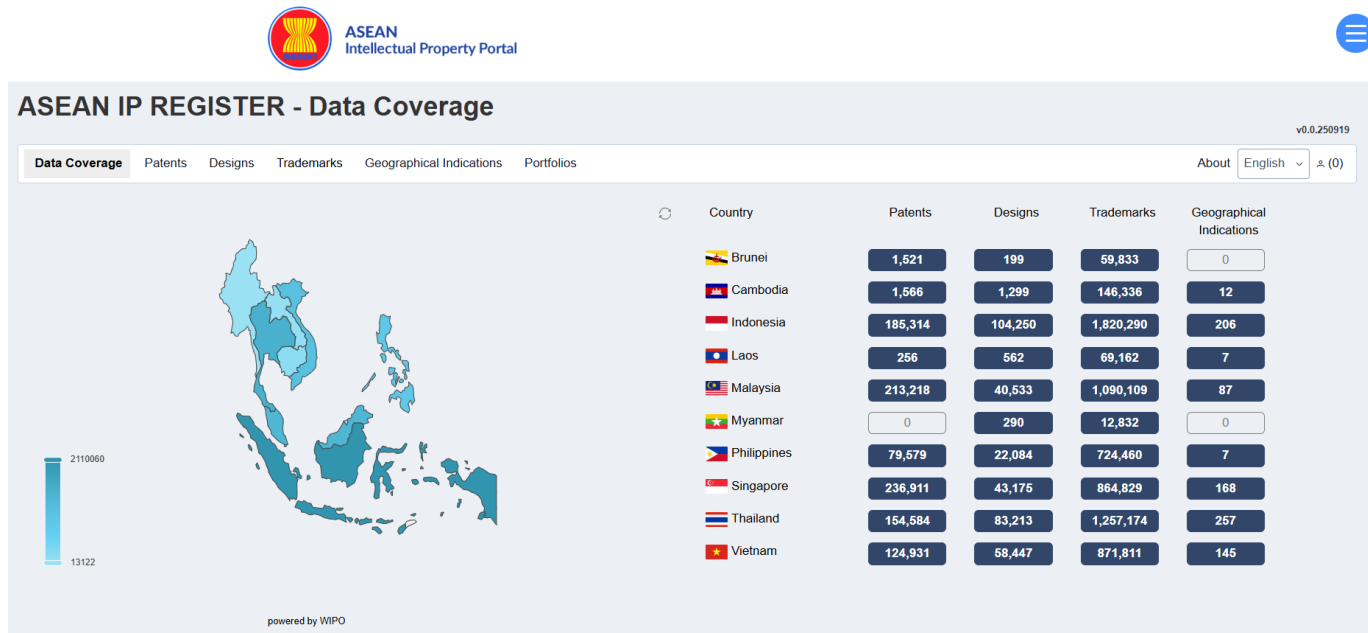

New Beta Version of ASEAN IP Register

- The way forward
 - Internationalize texts and labels in several languages
 - Collect AMS Offices feedbacks and refinement
 - Bug fixing
 - Proff of concept on logo search early 2026

Feature Improvements by 2025 (work in progress)

- A new IP Office Support portal
 - to manage data distribution to third parties (e.g. IP Offices): recipients and IP collections
 - to check shared authority files and data inconsistency issues found in the PCT minimum documentation shared by IP Offices through ASEAN / WIPO Publish Cloud IP Register

Feature Improvements by 2025 (work in progress)

- A new IP Office Support portal to manage data distribution

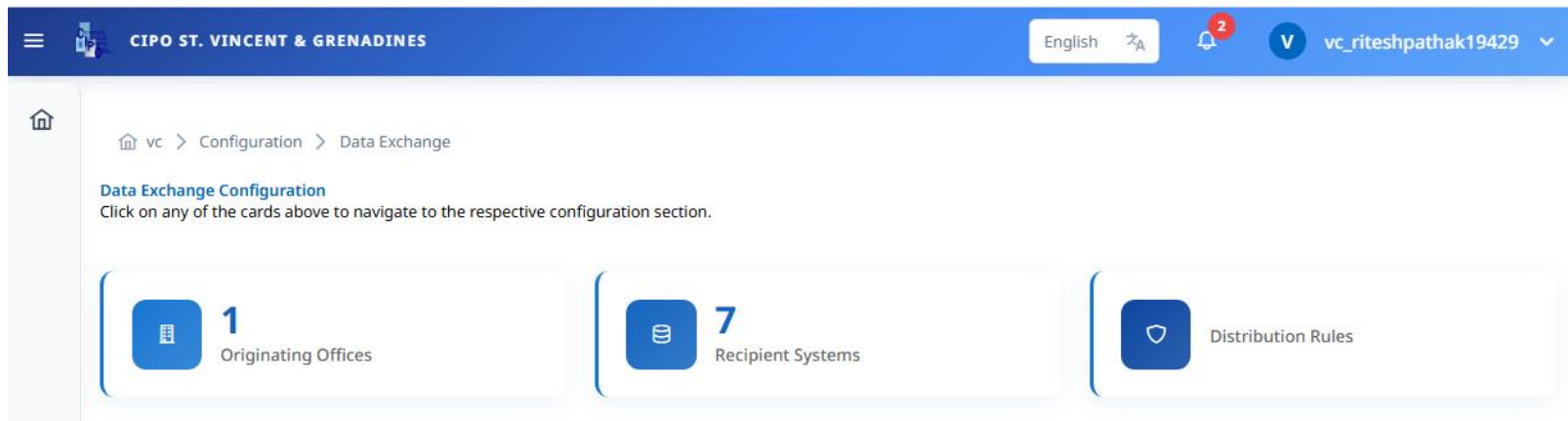

Feature Improvements by 2025 (work in progress)

- WIPO IPOBSD support team to manage data recipients on demand basis

CIPO ST. VINCENT & GRENADINES

English

vc_riteshpathak19429

vc > Configuration > Data Exchange > Recipient Systems

Recipient Systems

Configure systems that receive data from IP offices

7 Total Recipients

5 IP Types

50 Event Types

62 Document Types

Recipient Name	IP Types	Event Types	Document Types
> Japan Patent Office	Patents, Trademarks, Industrial Designs, Copyright, Geographical Indications	Patents: 2, Trademarks: 1, Industrial Designs: 2, Copyright: 1, Geographical Indications: 1	Patents: 2, Trademarks: 2, Industrial Designs: 2, Copyright: 1, Geographical Indications: 1
> European Patent Office	Patents, Trademarks, Industrial Designs, Copyright, Geographical Indications	Patents: 1, Trademarks: 2, Industrial Designs: 1, Copyright: 1, Geographical Indications: 1	Patents: 2, Trademarks: 2, Industrial Designs: 1, Copyright: 1, Geographical Indications: 1
> CIPO St. Vincent & Grenadines	Copyright, Trademarks	Copyright: 3, Trademarks: 2	Copyright: 3, Trademarks: 2
> IGQPI - Instituto de Gestão da Qualidade e da Propriedade Intelectual	Patents, Trademarks, Industrial Designs	Patents: 2, Trademarks: 2, Industrial Designs: 1	Patents: 3, Trademarks: 3, Industrial Designs: 2
> Bhutan Intellectual Property Office	Patents, Trademarks, Copyright, Geographical Indications	Patents: 3, Trademarks: 2, Copyright: 2, Geographical Indications: 1	Patents: 3, Trademarks: 2, Copyright: 2, Geographical Indications: 2
> Cambodia Department of Intellectual Property Rights	Patents, Trademarks, Industrial Designs, Copyright	Patents: 4, Trademarks: 3, Industrial Designs: 2, Copyright: 2	Patents: 4, Trademarks: 4, Industrial Designs: 3, Copyright: 3
> Cambodia Ministry of Commerce	Trademarks, Geographical Indications, Patents	Trademarks: 4, Geographical Indications: 2, Patents: 2	Trademarks: 5, Geographical Indications: 3, Patents: 3

Showing 1 to 7 of 7 entries

Feature Improvements by 2025 (work in progress)

- Distribution rules managed by data originating IP Offices: IP collection(s), published patent documents, registered patent applications only, full-text patent data, etc.

The screenshot displays the 'Distribution Rules' management interface for the CIPO ST. VINCENT & GRENADINES office. The top navigation bar includes the office name, language (English), and user profile (vc_riteshpathak19429). The main content area features three summary cards: 'Allowed Unpublished Applications' (1), 'Offices Covered' (0), and 'Total Rules' (4). Below these is a table of distribution rules with columns for Recipient Name, IP Category, Included Application Type, Documents Included, Event Codes, and Actions. A '+ Add Rule' button is located in the top right of the table area.

Recipient Name	IP Category	Included Application Type	Documents Included	Event Codes	Actions
Japan Patent Office	GI	Unpublished	GIL	KE007	[Edit] [Delete]
Japan Patent Office	PATENT	Published	CLM ABS	KE001 KE002	[Edit] [Delete]
Japan Patent Office	TRADEMARK	Published	IMG SND	KE003	[Edit] [Delete]
European Patent Office	PATENT	Published	CLM DES	KE010	[Edit] [Delete]

Feature Improvements by 2025 (work in progress)

■ Dashboard to check shared data packages

The dashboard displays the following statistics:

- TOTAL COUNT:** 15420 (Since 1999)
- TOTAL IN YEAR:** 1380 (Since 1 year)
- TOTAL IN MONTH:** 420 (Since 1 month)
- TOTAL IN WEEK:** 150 (Since 7 days)

Search File Name:

Shared Date: 2025-09-01 - 2025-09-22 Failed Partial

File name	IP Right Category	Shared Date	Processed Date	Status	Total Count	Processed Count	Actions
file6.zip	Industrial Designs	2025-09-03	2025-09-04 11:21:43	Partial	500	498	⋮
file8.zip	Patents	2025-09-04	2025-09-05 09:32:53	Partial	500	477	⋮
file9.zip	Trademarks	2025-09-05	2025-09-05 16:14:49	Failed	500	489	⋮
Patents_Cambodia_Packages_2025_September_04_Records...	Patents	2025-09-04	2025-09-05 15:49:57	Partial	500	497	⋮

Feature Improvements by 2025 (work in progress)

- Dashboard to check authority file content and missing data

The screenshot displays a dashboard for CIPO ST. VINCENT & GRENADINES. The top navigation bar includes the organization name, language settings (English), a notification bell with 2 alerts, and a user profile for vc_riteshpathak19429. The breadcrumb trail shows the path: vc > Data Sharing > Authority Files. The main content area is titled 'Authority Files' and features three summary cards: 'All' with 3222929 items since 2025, 'Patents' with 292929 items since 2025, and 'Utility Models' with 1288239 items since 2025. Below these cards is a search bar for 'Search Publication Number' and a set of action icons. A table below the search bar displays a list of publication records with columns for Publication Number, Publication Date, Kind Code, Exception Code, Abstract, Description, and Claims. The table shows five rows of data, all with 'ABST-en' abstracts and 'DESC-en' descriptions. The table is paginated, showing page 1 of 10.

Publication Number	Publication Date	Kind Code	Exception Code	Abstract	Description	Claims
1/2018/00502603	2025-07-02	A1		ABST-en	DESC-en	CLMS-en
1/2018/00502645	2025-06-07	U3		ABST-en	DESC-en	CLMS-en
1/2018/00502363	2025-07-07	U3		ABST-en	DESC-en	CLMS-en
1/2018/00501004	2025-07-05	B1		ABST-en	DESC-en	CLMS-en
1/2018/00502358	2025-07-31	A1		ABST-en	DESC-en	CLMS-en

New Data Sharing Tool in Q1 2026 (work in progress)

- Data Sharing in ST.96 format
- Authority files in CSV format
- IP statistics data in json