



INTELLECTUAL PROPERTY
OFFICE OF THE PHILIPPINES

Topic 5: Intellectual Property Office of the Philippines (IPOPHL) - Overview of IP Office Services, and IT Infrastructure and Systems Supporting the IP Office Operations

Prepared by:

Darlene Boyles-Barracas



INTELLECTUAL PROPERTY
OFFICE OF THE PHILIPPINES

Subsystems Interrelated to IPAS



INTELLECTUAL PROPERTY
OFFICE OF THE PHILIPPINES

REPUBLIC OF THE PHILIPPINES
INTELLECTUAL PROPERTY OFFICE OF THE PHILIPPINES

English (en) ▾

Apply to Register a Trademark Online

Apply for a trademark online

Fee 0

1 Trademark **2** Goods and Services **3** Priorities **4** Your Details **5** Confirm and Sign

Import Application XML
Export Application as XML
Reset Application Form
Print

Language

Language of the application: **English** .

Language *
English ▾

Type of mark

Which of the following types best describes the mark you want to apply for?

A Word mark

 Figurative mark

eDoc for Trademarks



INTELLECTUAL PROPERTY
OFFICE OF THE PHILIPPINES

REPUBLIC OF THE PHILIPPINES
INTELLECTUAL PROPERTY OFFICE OF THE PHILIPPINES

Input Language

English

File Trademark Documents Online

1 Request type 2 Affected Trademarks 3 Attachments and declarations 4 Applicants 5 Representatives 6 Confirmation

Request Type

? Help

Request group * -- All --

Request Type * -- Select --

Next

Intellectual Property Center, 28 Upper McKinley Road, McKinley Hill Town Center
Fort Bonifacio, Taguig City 1634 Philippines

T: +632-2386300 • Gen. Inquiries: Loc. 121 / 122/ 207 • Library: Loc. 205 •
TM Application Status: Loc. 503 or 502 • Inquiries on Madrid Protocol System: Loc. 507 / 509 / 513 •
F: +632-5539480 • www.ipophil.gov.ph

Trademarks

version 3.1.1 D



INTELLECTUAL PROPERTY
OFFICE OF THE PHILIPPINES

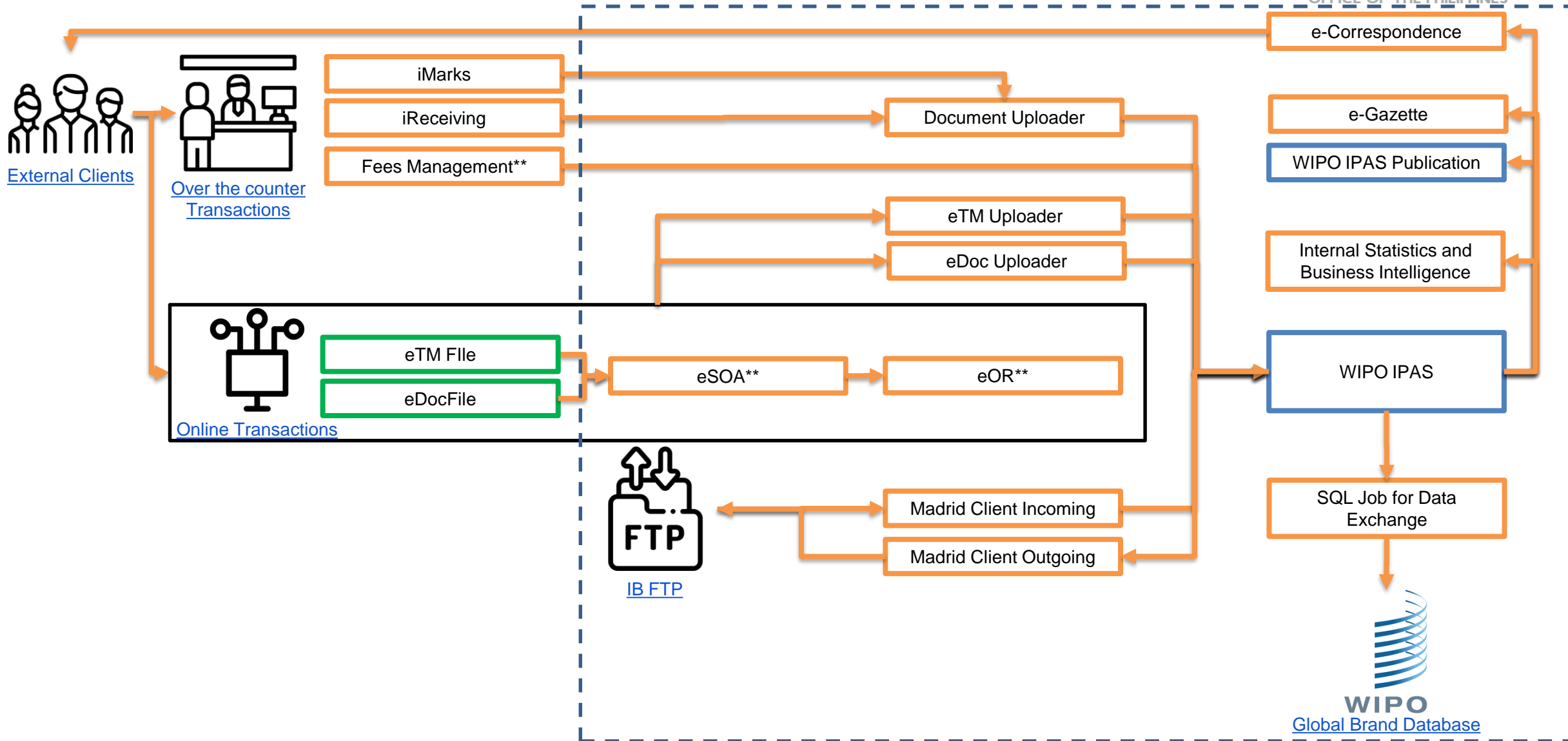

eInvention File



 **eInvFile** | Request for Grant of a Philippine Patent Online



[Reset Application](#) [Save my Application](#) [Open my saved Application](#)

BASIC INFORMATION

Title *

Application Category Chemical With Drawing(s) With Sequential Listing
 Mechanical With Drawing(s)

APPLICATION ROUTE

- Direct Route** - is a patent application filed with the Philippines as the first country of filing or a patent application claiming priority rights from previously filed foreign application under Sec. 31 of the IP Code.
- PCT Route** - is a patent application filed through the Patent Cooperation Treaty System.

Application Route Direct Route PCT Route

DIVISIONAL APPLICATION

- Divisional application (Section 31, RA 8293)** - is a patent application, divided-out from a parent application to comply with the requirement of unity of invention or a separate application of the parent application filed voluntarily.

Divisional Application Yes No

CLAIM FOR PRIORITY

- Claim Priority Rights** - an application claiming a priority date of a previously filed foreign application as the effective filing date in the Philippines by virtue of treaty, convention, or law that afford similar privileges to Filipino citizens.

eUM File



 **eUMFile** | Apply for a Utility Model Online



[Reset Application](#) [Save my Application](#) [Open my saved Application](#)

BASIC INFORMATION

Title *

Application Category Chemical With Drawing(s)
 Mechanical With Drawing(s)

APPLICATION ROUTE

Application Route Direct Route PCT Route

DIVISIONAL APPLICATION

Divisional Application Yes No

CLAIM FOR PRIORITY

Claim Priority Rights Yes No

[NEXT](#)

[Open my Application](#)

eID File



 **eIDFile** | Apply for a Design Online



[Reset Application](#) [Save my Application](#) [Open my saved Application](#)

Basic Information

Title *

Representative Drawing

- Perspective view of the Design must be uploaded as the representative drawing.
- Image shown may be distorted but actual image will be saved.

[UPLOAD](#)

Divisional Application

Divisional Application Yes No

Claim for Priority

- Applications claiming for priority rights should be filed strictly within six (6) months from the earliest filing date or priority date..

Claim Priority Rights Yes No

[NEXT](#)

eDoc for Patents



INTELLECTUAL PROPERTY
OFFICE OF THE PHILIPPINES

 INTELLECTUAL PROPERTY OFFICE OF THE PHILIPPINES

eDocFile | Patent documents online filing

- 1 Request(s)
- 2 Attachment(s)
- 3 Confirmation

Request

REQUEST FILE TYPE: Invention

REQUEST GROUP: -- ALL --

REQUEST TYPE:

- Annuity Payment (5th Yr - RA 8293)
- Annuity Payment (6th Yr - RA 8293)
- Annuity Payment (7th Yr - RA 8293)

REQUEST FOR APPLICATION: - enter Application No. or Title -

Q Enter Details

Request Details

NEXT

Patents

version 3.1.1 D



INTELLECTUAL PROPERTY
OFFICE OF THE PHILIPPINES

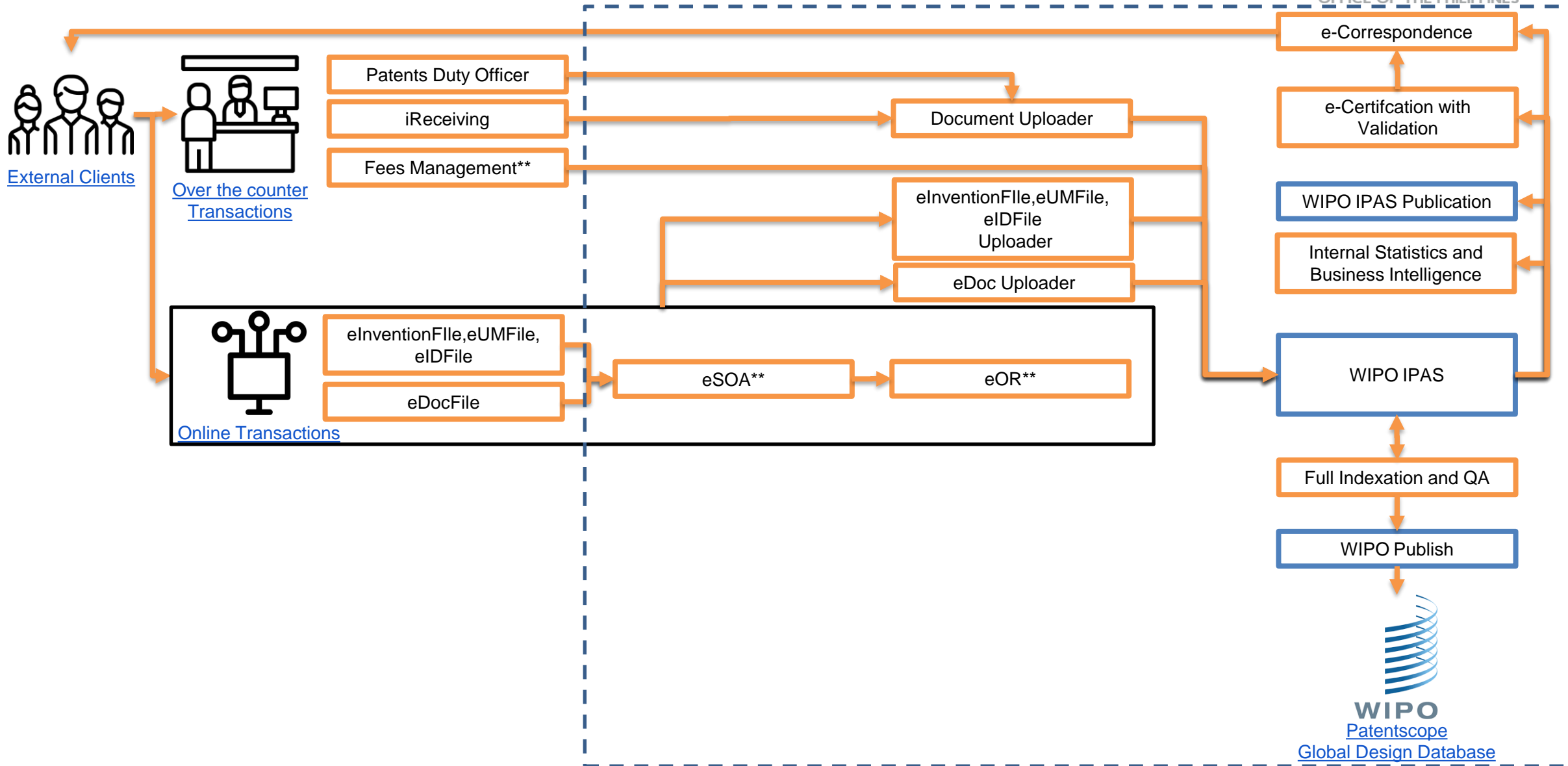

Legal

version 3.6.1 A



INTELLECTUAL PROPERTY
OFFICE OF THE PHILIPPINES

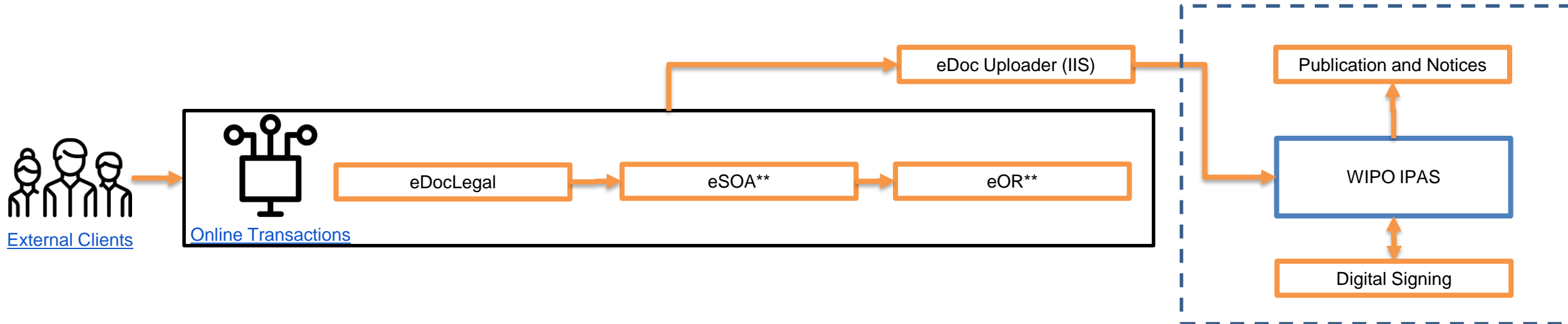

Server Configuration



INTELLECTUAL PROPERTY
OFFICE OF THE PHILIPPINES

- **Maximum Memory Allocation (50-75% available memory)**
- **Initial and Minimum Heap Size (10% of XMX)**
- **MaxPermGen (25% of available memory)**
- **MinPermGen - set to 10% of MaxPermgen or 2GB whichever is higher (DO NOT set this greater than Max Permgen)**

Trademarks



INTELLECTUAL PROPERTY
OFFICE OF THE PHILIPPINES

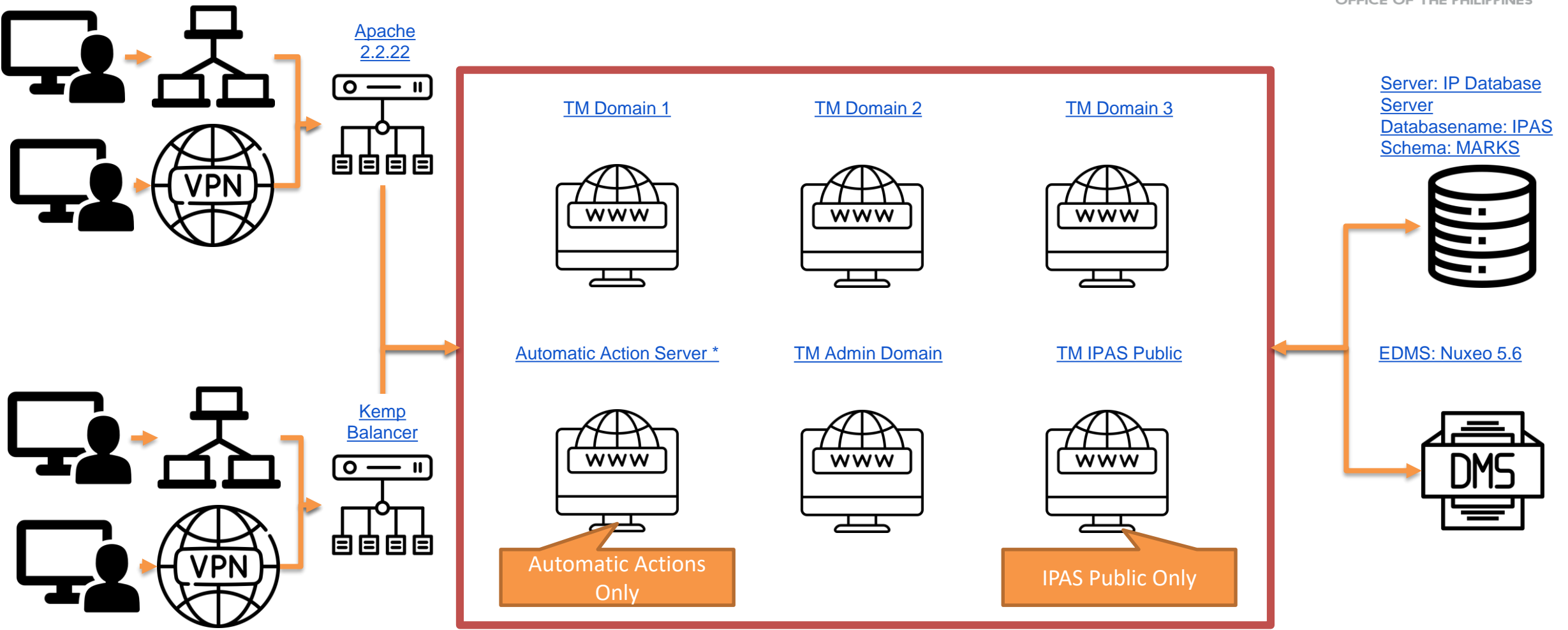

Patents



INTELLECTUAL PROPERTY
OFFICE OF THE PHILIPPINES

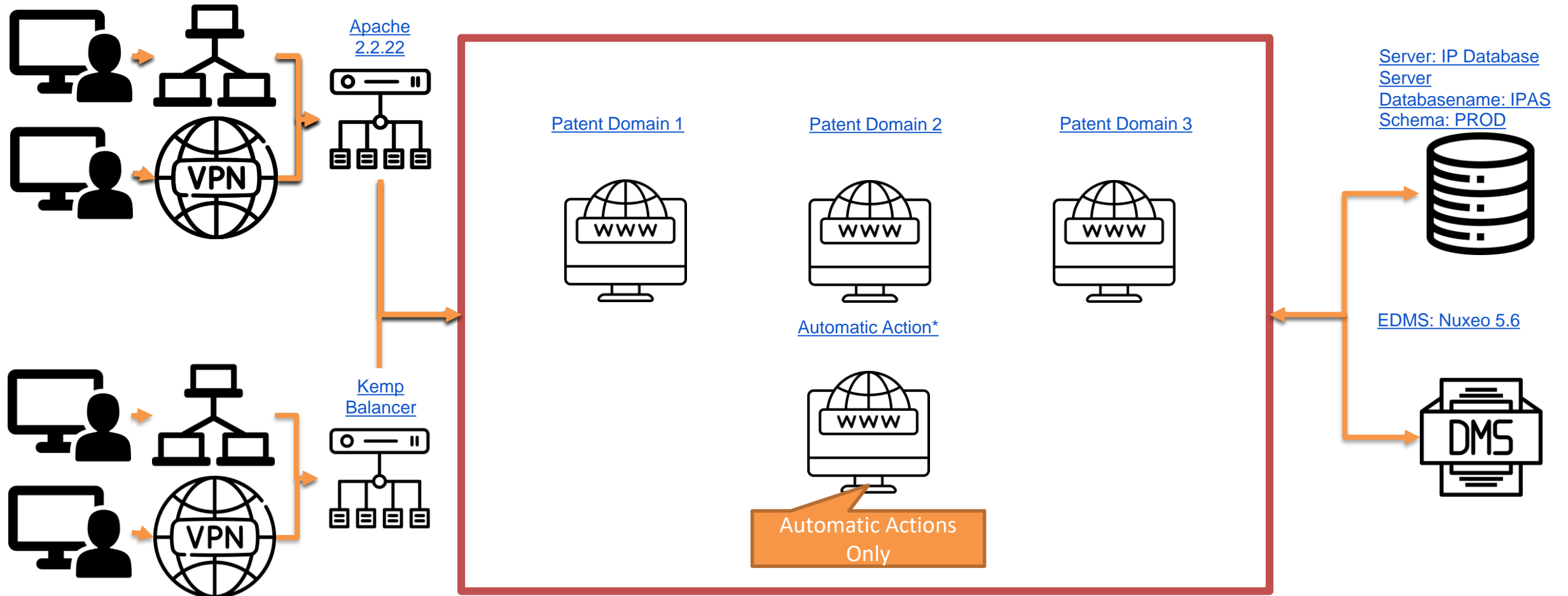

Legal



INTELLECTUAL PROPERTY
OFFICE OF THE PHILIPPINES

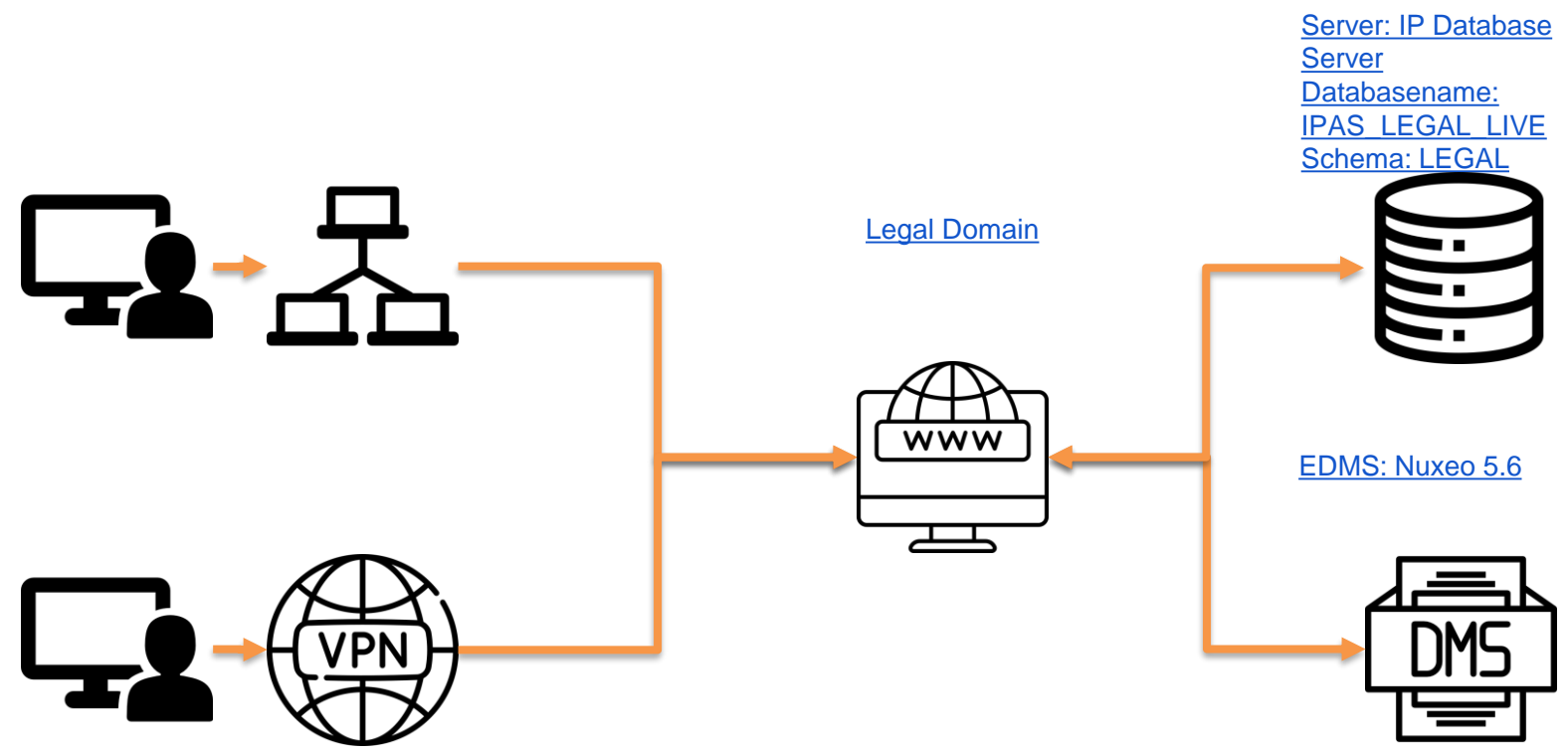

IP Database Server



INTELLECTUAL PROPERTY
OFFICE OF THE PHILIPPINES

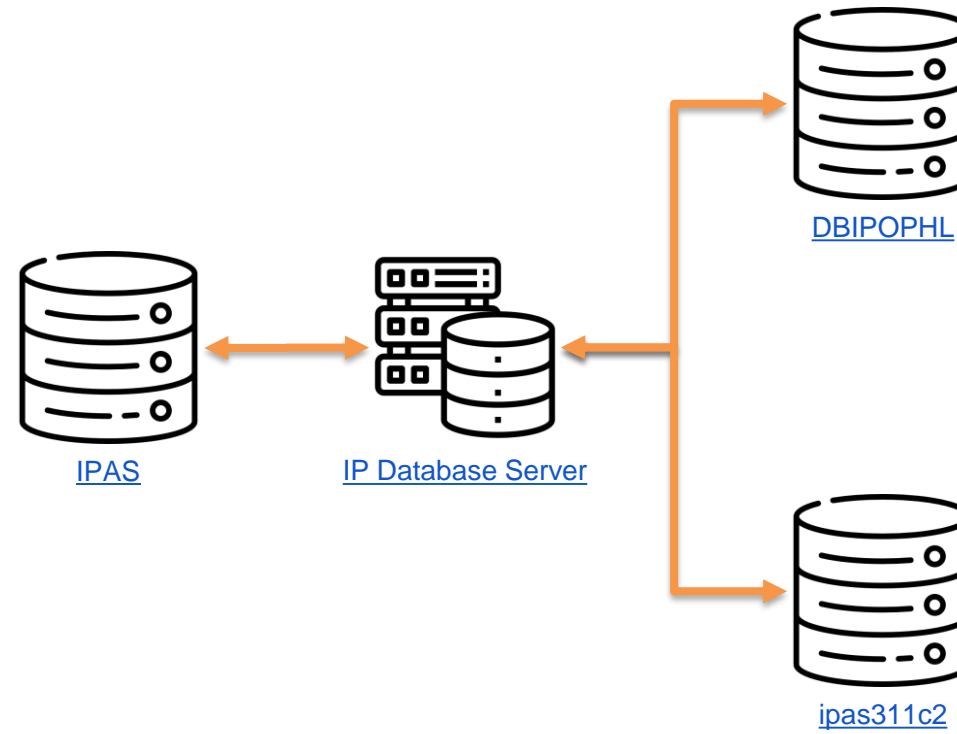

Non-IP Database Server



INTELLECTUAL PROPERTY
OFFICE OF THE PHILIPPINES

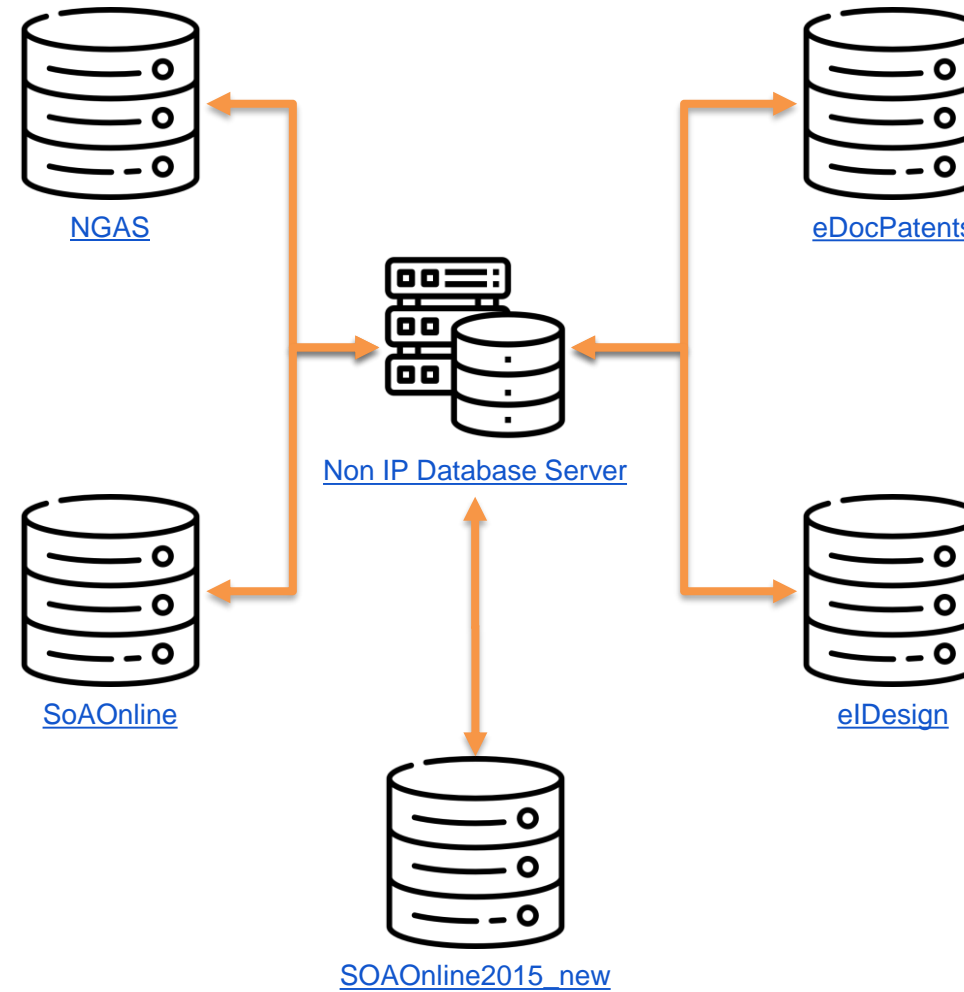

IT Database Test Server



INTELLECTUAL PROPERTY
OFFICE OF THE PHILIPPINES

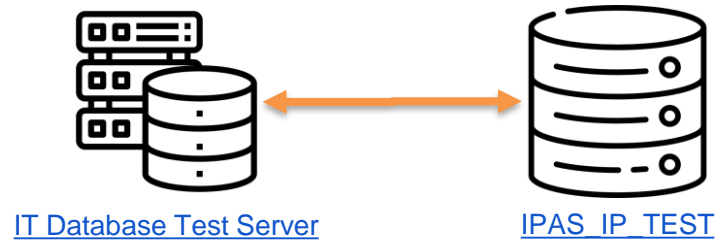



INTELLECTUAL PROPERTY
OFFICE OF THE PHILIPPINES

*Towards a Creative
and Innovative Philippines*

Contact Us:

Trunkline: (+632) 238.6300

Public Information Desk Local: 5405 to 5406

Application and Database Management Division
darlene.boyles@ipophil.gov.ph

Follow us:



<https://www.facebook.com/IPOPHL>



<https://twitter.com/ipophl>